

Spring 2020

FIDM

Style #	#MM-HL12	Theme	Limitless
Style Name	Formula 1 Hoodie	Designer	Marty McKenna
Sample Size	Unisex S	Delivery Date	2/1/2020
Size Range	Unisex XS-XXXL	Date Created	12/5/2018
Product Category	Knit Tops	Date Modified	2/21/2018
Description	Weatherproof unisex hoodie with STORM Cotton finishing		

HERBALIFE
NUTRITION
EST. 1980

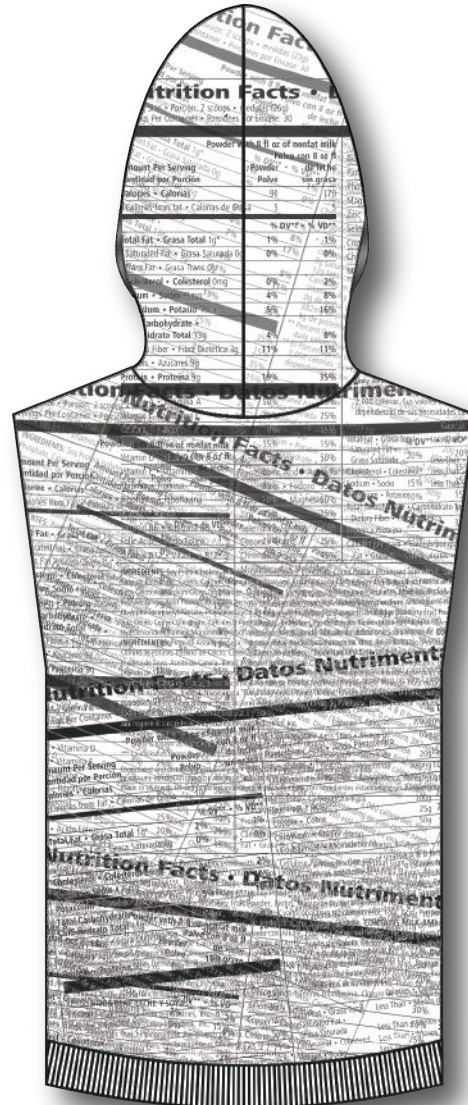
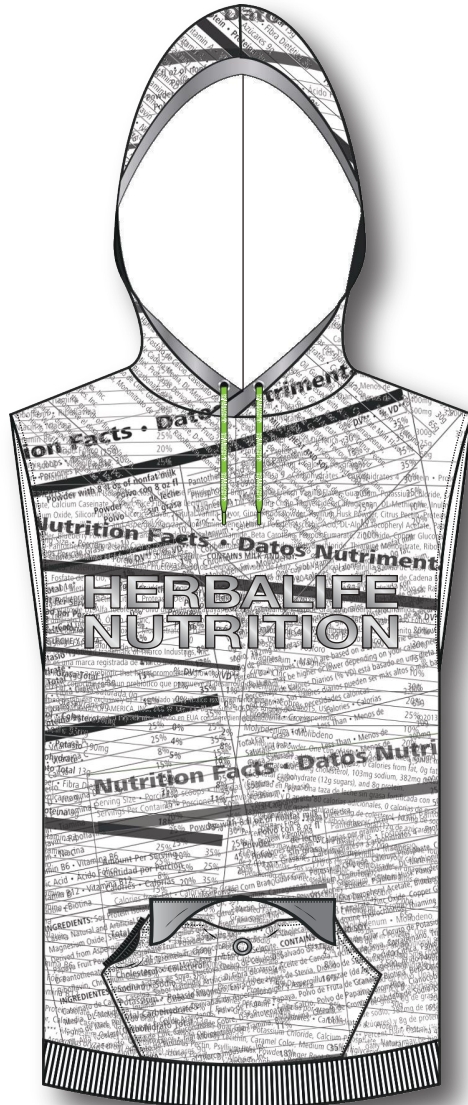

Spring 2020

Specification Sheet **FIDM**

Style #	#MM-HL12	Theme	Limitless
Style Name	Formula 1 Hoodie	Designer	Marty McKenna
Sample Size	Unisex S	Delivery Date	2/1/2020
Size Range	Unisex XS-XXXL	Date Created	12/5/2018
Product Category	Knit Tops	Date Modified	2/21/2018
Description	Weatherproof unisex hoodie with STORM Cotton finishing		



#	Measurement	Flat Measurements	Tolerance	Original	Actual	PP
1	Front Length from HPS		1/2	23	22 3/4	22 3/4
2	Side Length		1/2	14	13	13
3	Front Armhole Curved		3/8	9 1/2	8	8
4	Armhole Drop from HPS		3/8	10 1/2	10	10
5	Across Chest at Center Armhole (Edge to Edge)		3/8	14 1/2	14 1/2	14 1/2
6	Chest Width (1" below Armhole)		1/2	18	17 1/2	17 1/2
7	Across Shoulder (Edge to Edge)		1/4	18	17	17
8	Shoulder Width (Seam to Seam)		1/8	5	4 3/4	4 3/4
9	Shoulder Slope		1/8	2	2	2
10	Waist Placement from HPS		1/4	13	13	13
11	Waist Width		1/2	17 1/2	17 1/2	17 1/2
12	Ribbing Width		1/2	19	18 1/2	18 1/2
13	Ribbing Width Stretched		1/2	22	21	21
14	Ribbing Height		1/8	2	2	2
15	Neck Drop Front		1/8	3 1/2	4	4
16	Neck Width		1/8	9	8	8
17	Front Collar Length		1/8	13 1/2	13 1/4	13 1/4
18	Back Collar Length		1/8	9 1/2	9 1/4	9 1/4
19	Center Back Length		1/8	21	21 1/4	21 1/4
20	Back Armhole Curved		1/2	9	8	8
21	Across Back Length at Center Armhole		3/8	15	14 3/4	14 3/4
22	Front Hood Length		1/2	15	17	15
23	Back Hood Length		1/8	20	22 3/8	20
24	Hood Hem Height		1/8	1	1	1
25	Hood Overlap at Neckline (Edge to Edge)		1/8	1 1/2	1 5/8	1/2
26	Eyelet Length from Neckline		1/4	1	1	1 1/2
27	Pocket Flap Height		1/8	2 3/4	2 1/2	2 1/2
28	Pocket Flap Width		1/4	8 3/4	8	8
29	Kangaroo Pouch Height		1/4	7	7 3/4	7 3/4
30	Kangaroo Pouch Width		1/4	12 1/2	11 3/4	11 3/4
31	Pocket Opening Length		1/4	5	5	5

Front



Back



Spring 2020

Points of Measurement **FIDM**

Style #	#MM-HL12	Theme	Limitless
Style Name	Formula 1 Hoodie	Designer	Marty McKenna
Sample Size	Unisex S	Delivery Date	2/1/2020
Size Range	Unisex XS-XXXL	Date Created	12/5/2018
Product Category	Knit Tops	Date Modified	2/21/2018
Description	Weatherproof unisex hoodie with STORM Cotton finishing		



Front

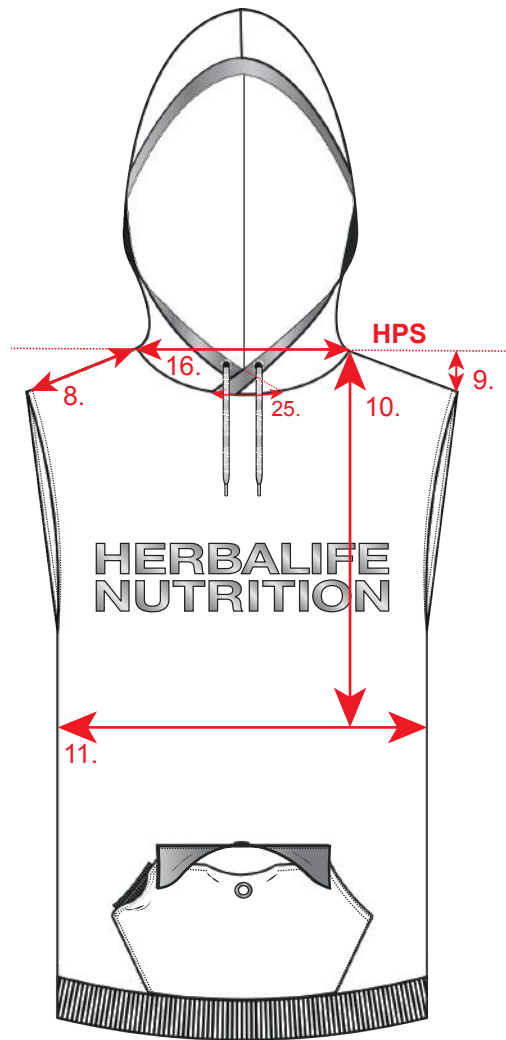
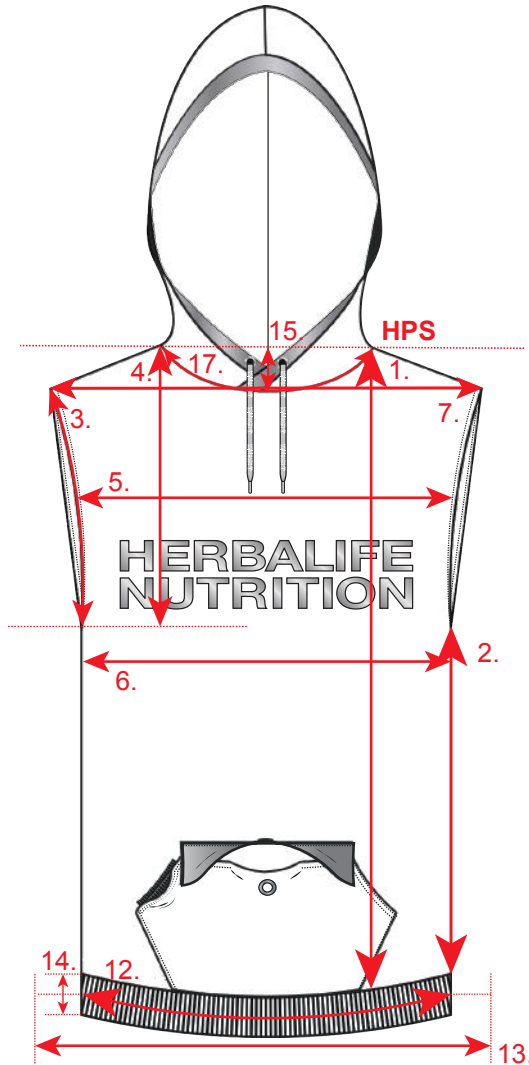

Spring 2020

Points of Measurement **FIDM**

Style #	#MM-HL12	Theme	Limitless
Style Name	Formula 1 Hoodie	Designer	Marty McKenna
Sample Size	Unisex S	Delivery Date	2/1/2020
Size Range	Unisex XS-XXXL	Date Created	12/5/2018
Product Category	Knit Tops	Date Modified	2/21/2018
Description	Weatherproof unisex hoodie with STORM Cotton finishing		



Back

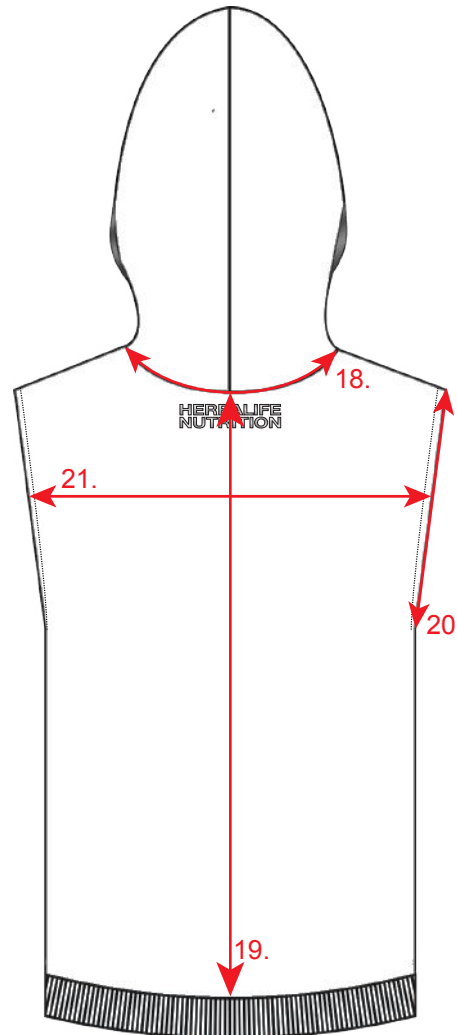

Spring 2020

Points of Measurement **FIDM**

Style #	#MM-HL12	Theme	Limitless
Style Name	Formula 1 Hoodie	Designer	Marty McKenna
Sample Size	Unisex S	Delivery Date	2/1/2020
Size Range	Unisex XS-XXXL	Date Created	12/5/2018
Product Category	Knit Tops	Date Modified	2/21/2018
Description	Weatherproof unisex hoodie with STORM Cotton finishing		

HERBALIFE
NUTRITION
EST. 1980



Details

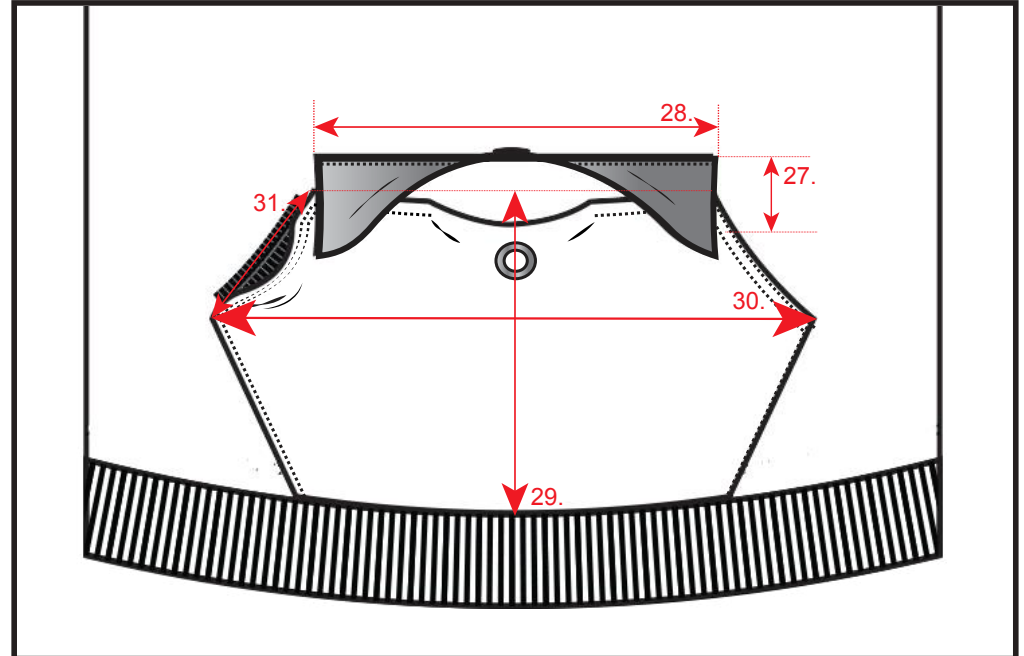
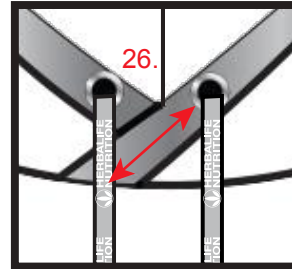
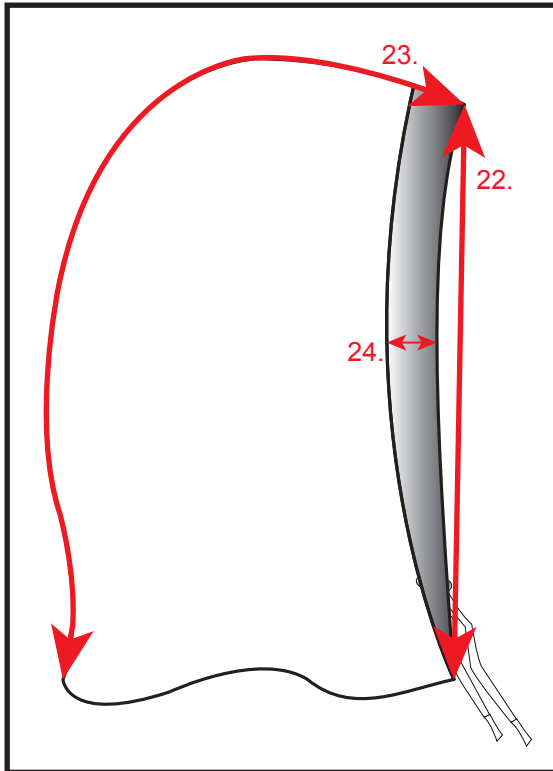

Spring 2020

Construction Details **FIDM**

Style #	#MM-HL12	Theme	Limitless
Style Name	Formula 1 Hoodie	Designer	Marty McKenna
Sample Size	Unisex S	Delivery Date	2/1/2020
Size Range	Unisex XS-XXXL	Date Created	12/5/2018
Product Category	Knit Tops	Date Modified	2/21/2018
Description	Weatherproof unisex hoodie with STORM Cotton finishing		



Front

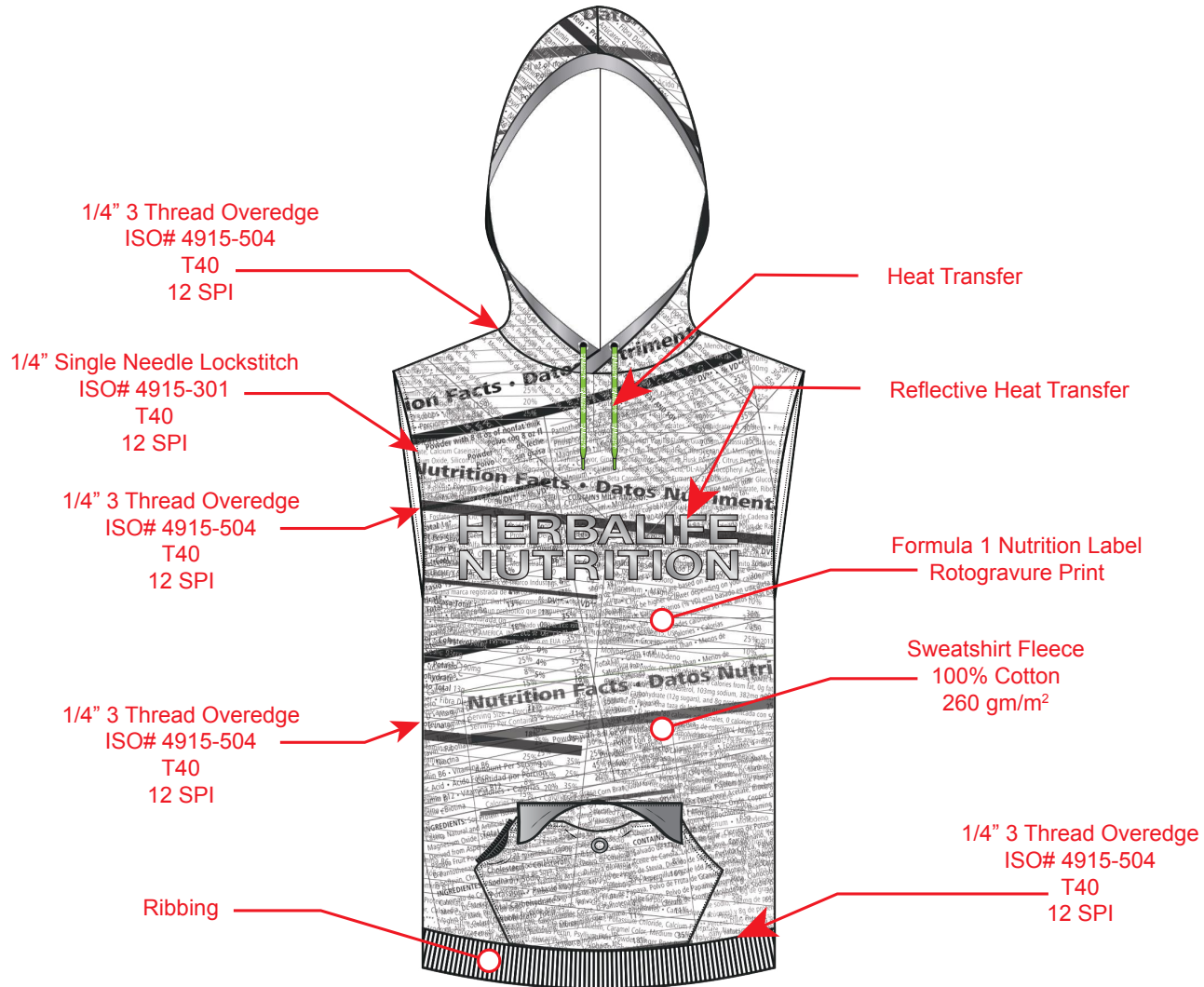

Spring 2020

Construction Details **FIDM**

Style #	#MM-HL12	Theme	Limitless
Style Name	Formula 1 Hoodie	Designer	Marty McKenna
Sample Size	Unisex S	Delivery Date	2/1/2020
Size Range	Unisex XS-XXXL	Date Created	12/5/2018
Product Category	Knit Tops	Date Modified	2/21/2018
Description	Weatherproof unisex hoodie with STORM Cotton finishing		

HERBALIFE
NUTRITION
EST. 1980



Back

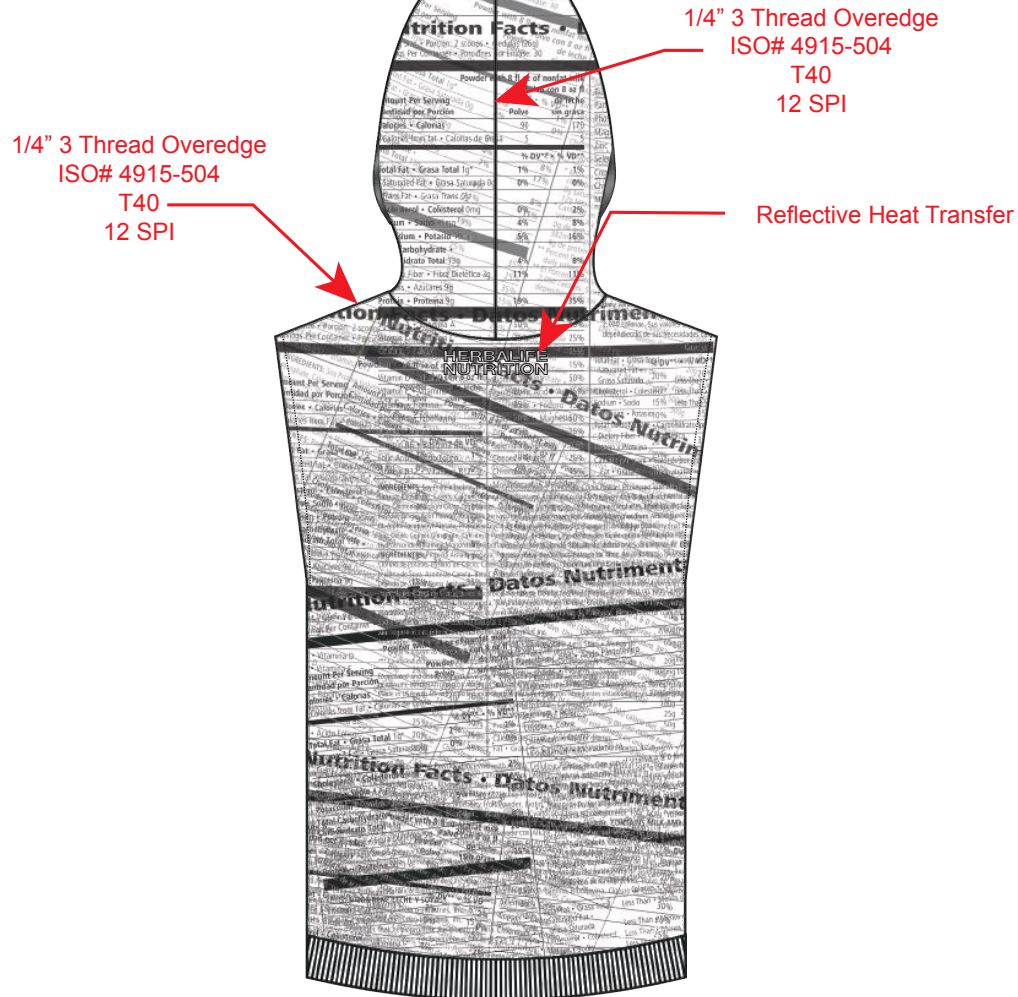

Spring 2020

Construction Details **FIDM**

Style #	#MM-HL12	Theme	Limitless
Style Name	Formula 1 Hoodie	Designer	Marty McKenna
Sample Size	Unisex S	Delivery Date	2/1/2020
Size Range	Unisex XS-XXXL	Date Created	12/5/2018
Product Category	Knit Tops	Date Modified	2/21/2018
Description	Weatherproof unisex hoodie with STORM Cotton finishing		



Details

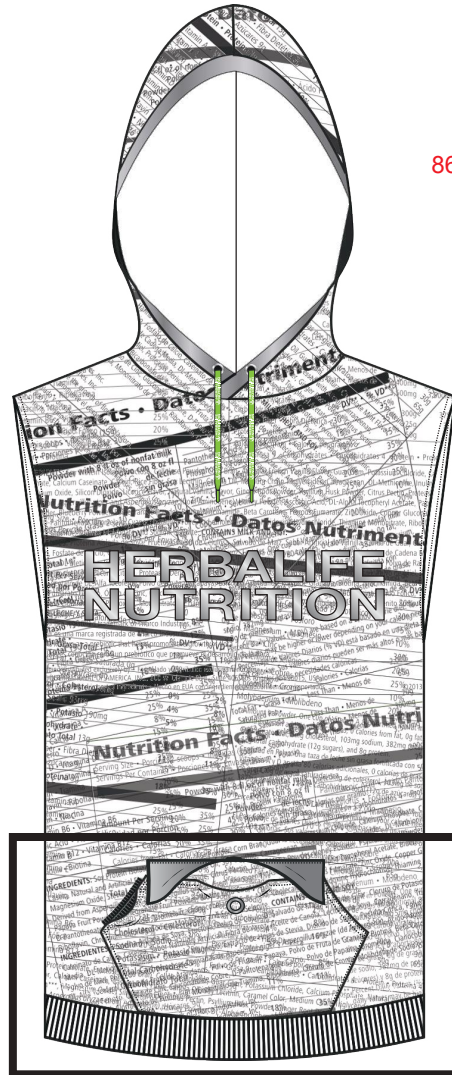

Reflective Spandex
86% Polyester 14% Elastane
190 gm/m²

Metal Snap Button
22L/14.2mm

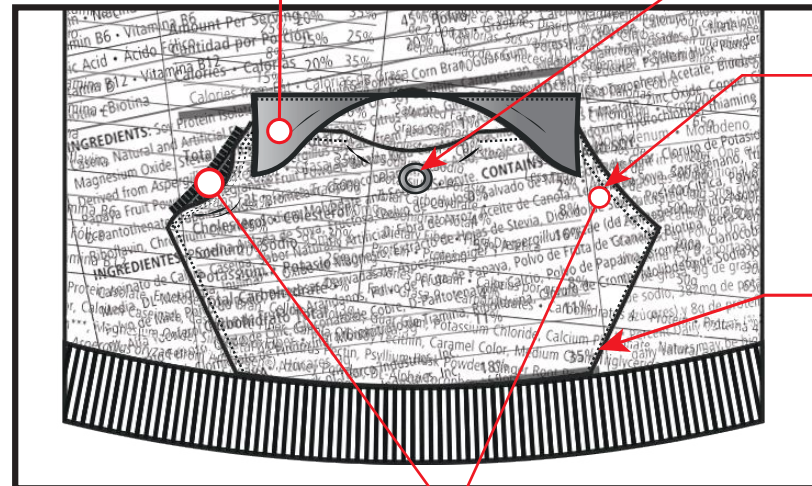

1/4" 2 Needle Bottom
Coverstitch
ISO# 4915-406
T40
12 SPI

1/4" Single Needle
Lockstitch
ISO# 4915-301
T40
12 SPI

5" Reverse
Coil Zippers

Spring 2020

Graphic Placement **FIDM**

Style #	#MM-HL12	Theme	Limitless
Style Name	Formula 1 Hoodie	Designer	Marty McKenna
Sample Size	Unisex S	Delivery Date	2/1/2020
Size Range	Unisex XS-XXXL	Date Created	12/5/2018
Product Category	Knit Tops	Date Modified	2/21/2018
Description	Weatherproof unisex hoodie with STORM Cotton finishing		



Front



**HERBALIFE
NUTRITION**



1.

#	Measurement	PP
1	Logo Width	11
2	Length from Ribbing at Center Front	12 1/2

Spring 2020

Graphic Placement **FIDM**

Style #	#MM-HL12	Theme	Limitless
Style Name	Formula 1 Hoodie	Designer	Marty McKenna
Sample Size	Unisex S	Delivery Date	2/1/2020
Size Range	Unisex XS-XXXL	Date Created	12/5/2018
Product Category	Knit Tops	Date Modified	2/21/2018
Description	Weatherproof unisex hoodie with STORM Cotton finishing		



Back

HERBALIFE NUTRITION

EST. 1980



#	Measurement	PP
1	Logo Width	4
2	Length from Ribbing at Center Front	12 1/2

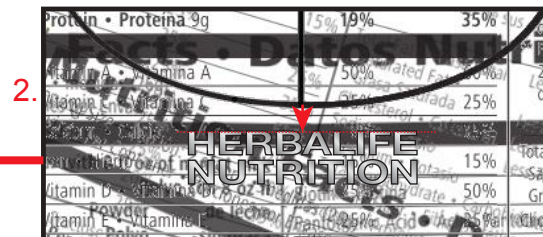
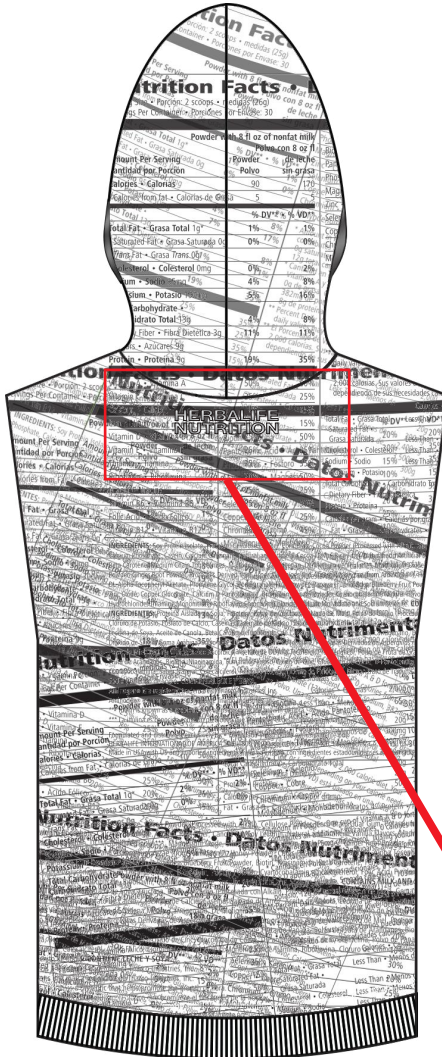

Spring 2020

Graphic Placement **FIDM**

Style #	#MM-HL12	Theme	Limitless
Style Name	Formula 1 Hoodie	Designer	Marty McKenna
Sample Size	Unisex S	Delivery Date	2/1/2020
Size Range	Unisex XS-XXXL	Date Created	12/5/2018
Product Category	Knit Tops	Date Modified	2/21/2018
Description	Weatherproof unisex hoodie with STORM Cotton finishing		

HERBALIFE
NUTRITION
EST. 1980



Drawstring

Artwork Color: 15-0545 TCX

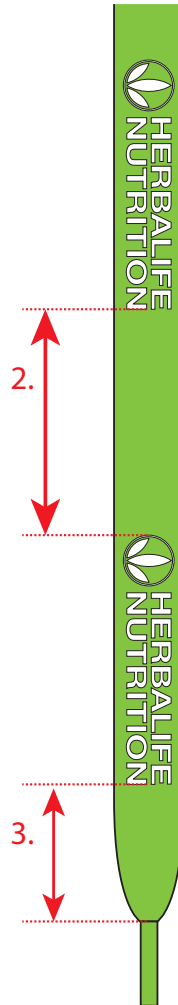
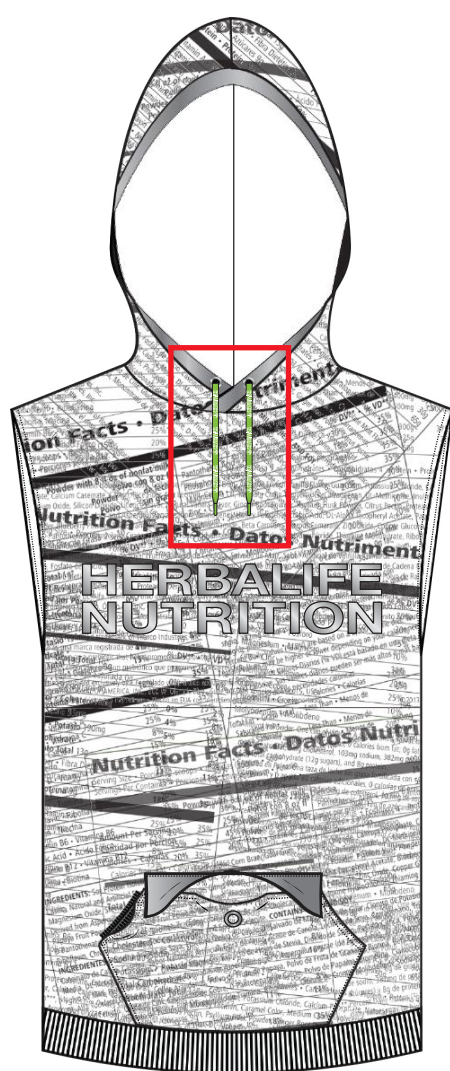

#	Measurement	PP
1	Logo Width	1 1/2
2	Distance in between Logos	1 1/2
3	Distance from aglet	1

Printed throughout length of drawstring

Spring 2020

Label Placement **FIDM**

Style #	#MM-HL12	Theme	Limitless
Style Name	Formula 1 Hoodie	Designer	Marty McKenna
Sample Size	Unisex S	Delivery Date	2/1/2020
Size Range	Unisex XS-XXXL	Date Created	12/5/2018
Product Category	Knit Tops	Date Modified	2/21/2018
Description	Weatherproof unisex hoodie with STORM Cotton finishing		

HERBALIFE
NUTRITION
EST. 1980

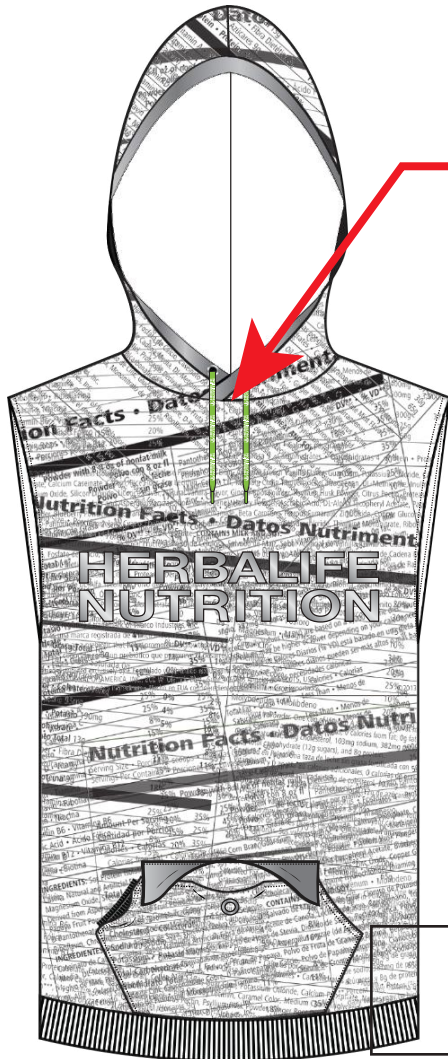

**HERBALIFE
NUTRITION**

Standard / Estándar / Suelto SM/P/P

Made in China / Fabrique En China / La Norme



#	Measurement	PP
1	Label Width	2 1/2
2	Care Label Length from Ribbing	3

CARE LABEL 100% Cotton

RN: 3456791

Fabric: (Main)
100% Cotton
(Accent)
86% Polyester 14% Elastane

Wash Instructions



Made in Korea



Specifications

- **100% Cotton Tag**
- **Color: Herbalife 15-0545 TCX**
- **Sewn into neckline inside garment at center back**

Spring 2020

Fit Session **FIDM**

Style #	#MM-HL12	Theme	Limitless
Style Name	Formula 1 Hoodie	Designer	Marty McKenna
Sample Size	Unisex S	Delivery Date	2/1/2020
Size Range	Unisex XS-XXXL	Date Created	12/5/2018
Product Category	Knit Tops	Date Modified	2/21/2018
Description	Weatherproof unisex hoodie with STORM Cotton finishing		

HERBALIFE
NUTRITION
EST. 1980



Pictures



Front



Right



Left

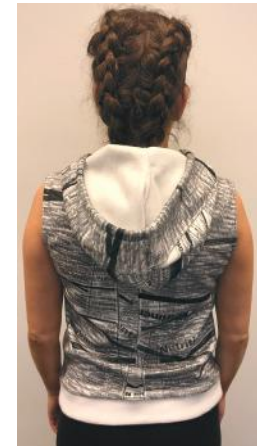

Back



Front



Right



Left

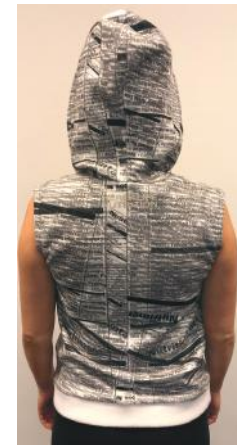

Back

Spring 2020

Fit Session **FIDM**

Style #	#MM-HL12	Theme	Limitless
Style Name	Formula 1 Hoodie	Designer	Marty McKenna
Sample Size	Unisex S	Delivery Date	2/1/2020
Size Range	Unisex XS-XXXL	Date Created	12/5/2018
Product Category	Knit Tops	Date Modified	2/21/2018
Description	Weatherproof unisex hoodie with STORM Cotton finishing		



Notes

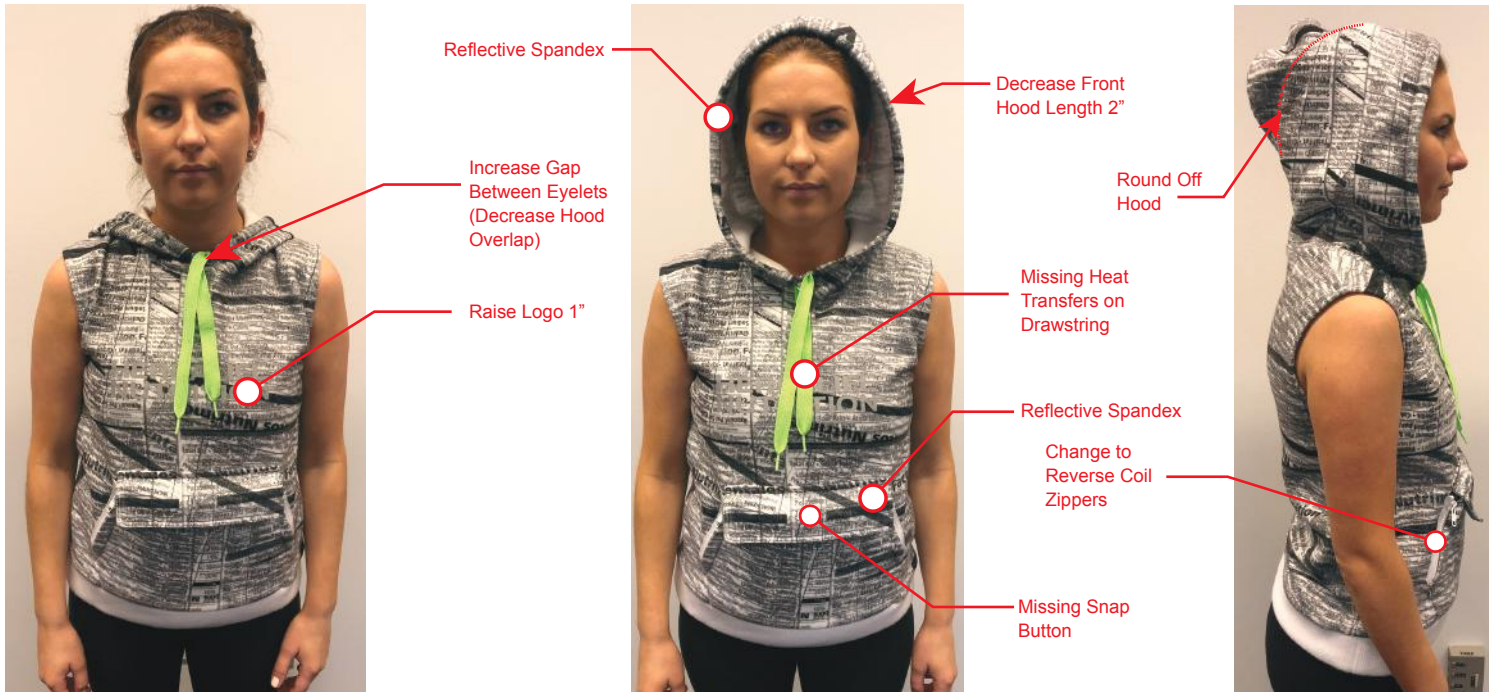

*2nd Sample Requested

Spring 2020

Fabric Details **FIDM**

Style #	#MM-HL12	Theme	Limitless
Style Name	Formula 1 Hoodie	Designer	Marty McKenna
Sample Size	Unisex S	Delivery Date	2/1/2020
Size Range	Unisex XS-XXXL	Date Created	12/5/2018
Product Category	Knit Tops	Date Modified	2/21/2018
Description	Weatherproof unisex hoodie with STORM Cotton finishing		

HERBALIFE
NUTRITION
EST. 1980



Sweatshirt Fleece

100% Cotton
260 gm/m²



Reflective Spandex

86% Polyester 14% Elastane
190 gm/m²

Spring 2020

Style #	#MM-HL12	Theme	Limitless
Style Name	Formula 1 Hoodie	Designer	Marty McKenna
Sample Size	Unisex S	Delivery Date	2/1/2020
Size Range	Unisex XS-XXXL	Date Created	12/5/2018
Product Category	Knit Tops	Date Modified	2/21/2018
Description	Weatherproof unisex hoodie with STORM Cotton finishing		

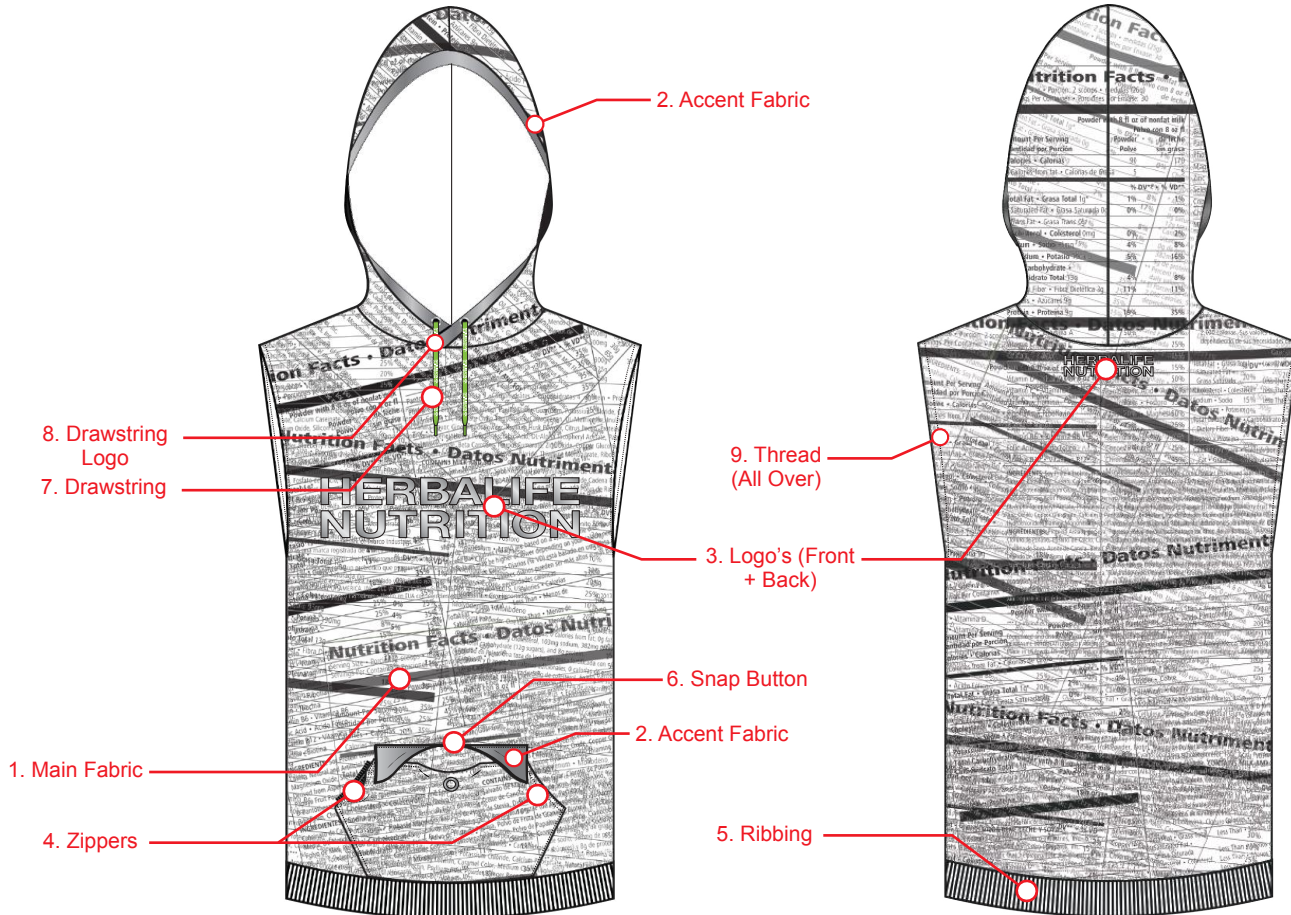

	1. Main Fabric	2. Accent Fabric	3. Logo (Front + Back)	4. Zippers (All)	5. Ribbing	6. Snap Button	7. Drawstring	8. Drawstring Logo	9. Thread (All Over)
	Pantone	Pantone	Pantone	Pantone	Pantone	Pantone	Pantone	Pantone	Pantone
A	Formula 1 Print	Reflective	Reflective	Black 19-400C TCX	White 11-0601 TCX	Barbell 14-4203 TCX	Black 19-400C TCX	White 11-0601 TCX	Black 19-400C TCX

Spring 2020

Packaging **FIDM**

Style #	#MM-HL12	Theme	Limitless
Style Name	Formula 1 Hoodie	Designer	Marty McKenna
Sample Size	Unisex S	Delivery Date	2/1/2020
Size Range	Unisex XS-XXXL	Date Created	12/5/2018
Product Category	Knit Tops	Date Modified	2/21/2018
Description	Weatherproof unisex hoodie with STORM Cotton finishing		



Materials



Tag Fastener



Packaging Tape

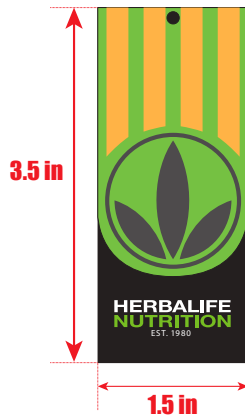

Hangtag

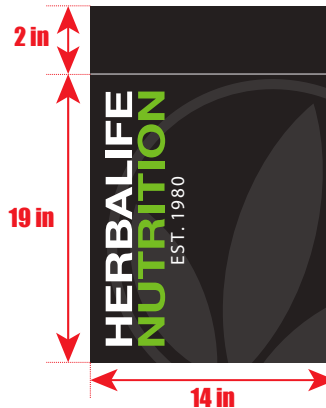

Poly Bag

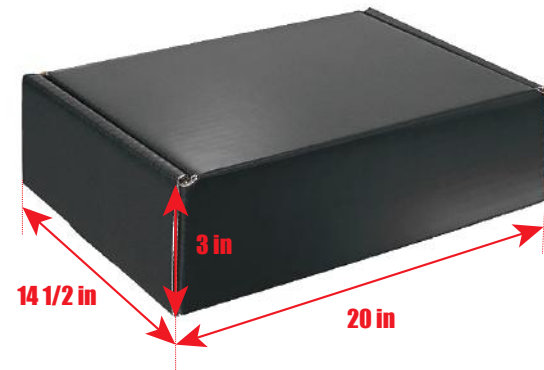

Cardboard Box

Spring 2020

Packaging **FIDM**

Style #	#MM-HL12	Theme	Limitless
Style Name	Formula 1 Hoodie	Designer	Marty McKenna
Sample Size	Unisex S	Delivery Date	2/1/2020
Size Range	Unisex XS-XXXL	Date Created	12/5/2018
Product Category	Knit Tops	Date Modified	2/21/2018
Description	Weatherproof unisex hoodie with STORM Cotton finishing		

HERBALIFE
NUTRITION
EST. 1980



Hangtag

Front



Back

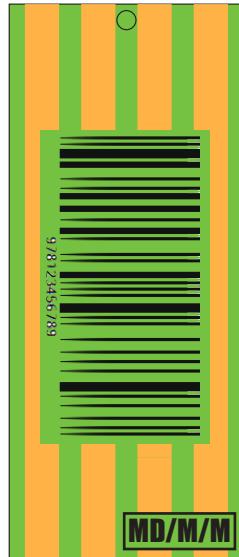

Open

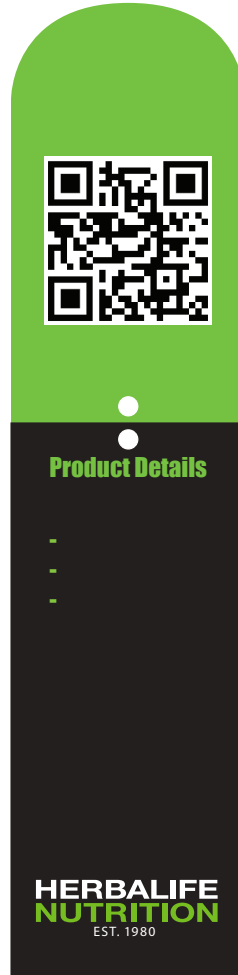

Attached at seam
on the bottom of
right armhole

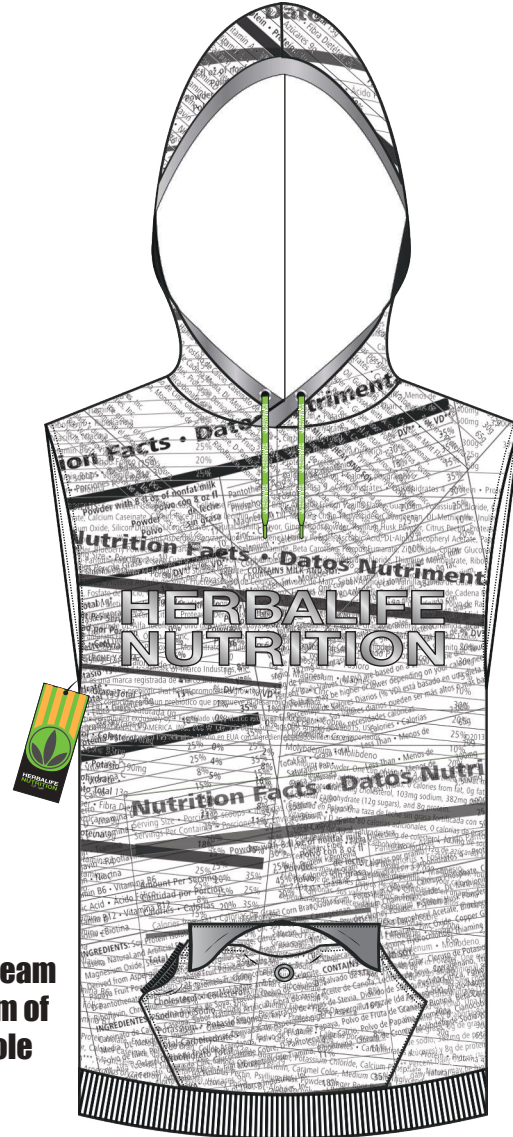

Spring 2020

Packaging **FIDM**

Style #	#MM-HL12	Theme	Limitless
Style Name	Formula 1 Hoodie	Designer	Marty McKenna
Sample Size	Unisex S	Delivery Date	2/1/2020
Size Range	Unisex XS-XXXL	Date Created	12/5/2018
Product Category	Knit Tops	Date Modified	2/21/2018
Description	Weatherproof unisex hoodie with STORM Cotton finishing		

HERBALIFE
NUTRITION
EST. 1980



Folding Instruction



1. Lay garment flat



2. Flip garment face down



3. Fold hood of garment back

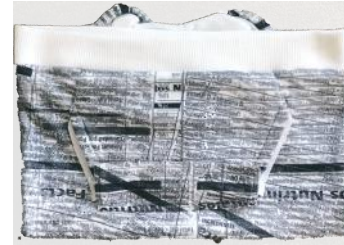

4. Flip up the bottom hem of garment to meet top of armholes



5. Flip garment face up



6. Insert garment into poly bag face up



7. Fold over poly bag flap and seal shut



8. Insert poly bag face up into cardboard box



9. Tape box shut at center and on sides

Spring 2020

Bill of Materials **FIDM**

Style #	#MM-HL12	Theme	Limitless
Style Name	Formula 1 Hoodie	Designer	Marty McKenna
Sample Size	Unisex S	Delivery Date	2/1/2020
Size Range	Unisex XS-XXXL	Date Created	12/5/2018
Product Category	Knit Tops	Date Modified	2/21/2018
Description	Weatherproof unisex hoodie with STORM Cotton finishing		



Material	Fiber Content	Color	Size/Width	Unit of Measure	Quantity
----------	---------------	-------	------------	-----------------	----------

Fabric

Sweatshirt Fleece	100% Cotton	260 gm/m ²	Formula 1 Print	58"	YD	1 1/2
Reflective Spandex	86% Polyester 14% Elastane	190 gm/m ²	Reflective	58"	YD	1/4

Trim

Drawstring	100% Cotton	Herbalife 15-0545 TCX	3/4"	PCS	1
Ribbing	100% Cotton	White 11-0601 TCX	8"	PCS	1
Reverse Coil Zipper	Nylon	White 11-0601 TCX	5"	PCS	2
Elastic	70% Polyester 30% Nylon	Black 19-400C TCX	1/4"	PCS	1
Eyelets	Metal	Barbell 14-4203 TCX	15mm/24L	PCS	1
Snap Button	Metal	Barbell 14-4203 TCX	15mm/24L	PCS	1

Thread

All Over	100% Polyester	Black 19-400C TCX	T40	Spool	1
----------	----------------	-------------------	-----	-------	---

Labels

Care Label	100% Cotton	White 11-0601 TCX	1"	PCS	1
Hangtag	100% Cotton	Herbalife 15-0545 TCX	2 1/2"	PCS	2

Sendouts

STORM Cotton	-	-	-	Application	1
Rotogravure Print	-	-	-	Application	1
Heat Transfer	-	-	-	Application	3

